T&R Test Equipment Ltd

OPERATING AND MAINTENANCE MANUAL

Product: **3 Phase Secondary Injection Test Set**
Type: **50A-3PH mk2**



DESIGNED AND MANUFACTURED BY:

T & R Test Equipment Limited

15-16 Woodbridge Meadows, Guildford, Surrey, GU1 1BJ, United Kingdom

Telephone: 01483 207428

Fax.: 01483 511229

e-mail:

Web:

sales@trtest.com

www.trtest.com

GENERAL SAFETY STATEMENT



WARNING

The following safety precautions should be reviewed to avoid injury to the user and damage to the product (and other products connected to it). To avoid potential hazards only use this product as specified.

- **Only suitably qualified personnel should use this equipment.**
Servicing of this product should only be carried out by suitably qualified service personnel.

To Avoid Fire Hazards and Personal Injury

- Use the correct power supply lead. Only use a suitably rated and approved power supply lead for the country of use.
- Ensure that systems that the unit is to be connected to are dead.
- Do not connect and disconnect leads whilst outputs are switched on. Breaking the output circuit with current flowing may cause potentially fatal arcing.
- Ensure that the product is grounded. To avoid electric shock it is essential that the grounding conductor is connected to the earth ground. An additional earth terminal is provided on the unit that should be connected to a local earth. Ensure that the unit is properly grounded before making any connections to inputs or outputs.
- Terminal ratings must be observed to prevent fire hazards and risk of injury to the operator. Consult the product manual for ratings information before making connections to any terminal.
- It is ESSENTIAL to consult the product manual for rating information before making any connection to a terminal or terminal group marked with a warning triangle.
- Only use fuses of a type and rating specified for this product.
- Do not operate the unit out of its case or with any covers or panels removed.
- Do not touch exposed connections and components when power is present.
- Do not operate the product if any damage is suspected. Refer the unit to qualified service personnel to be checked.
- Do not operate the unit in wet or damp conditions
- Do not operate the unit in an explosive atmosphere
- The 50A-3PH mk2 system has a high output current (up to 50A), and therefore generates large magnetic fields around the output leads. Care must be taken in siting the unit next to items sensitive to magnetic fields (such as computer monitors and other sensitive equipment).
- Warnings from cardiac pacemaker manufacturers state that strong magnetic fields may affect operation. Any high current unit such as the 50A-3PH mk2 should therefore not be operated by, or in the vicinity of persons fitted with cardiac pacemakers or any other electronic or electrical medical implants.

If any further queries occur regarding the usage and maintenance of the equipment detailed in this manual, please refer these to the supplier of the equipment in the first case or to the manufacturer, T & R Test Equipment Limited.

SAFETY TERMS AND SYMBOLS

The following safety symbols appear on the equipment:



CAUTION/WARNING – Refer to manual



Mains off



Mains on

The following safety symbols appear in this manual:



CAUTION

This action or procedure may be dangerous if not carried out correctly, and may cause damage to the equipment or connected equipment.



WARNING

This action or procedure may cause injury or death to the operator or other personnel if not carried out correctly using applicable safety procedures.

CONTENTS

1.	DESCRIPTION OF EQUIPMENT	9
1.1	Front Panel Layout	10
1.2	Installation	11
1.2.1	Environment	11
1.2.2	Supply Requirements	11
1.2.3	Supply Voltage Connections	11
1.3	Functions	13
1.3.1	Main Current Outputs	13
1.3.2	Current Metering	13
1.3.3	Auxiliary AC Voltage Output	14
1.3.4	Auxiliary Metering Input	14
1.3.5	Timing System Specification	15
1.3.6	Contact Inputs	16
1.3.7	Vdc Contact Input	16
1.4	Displayed Values and Messages	17
1.4.1	Displayed Values	17
1.4.2	Warning Messages	17
1.5	Overload Protection	18
2.	OPERATION	19
2.1	Main Output Connection	19
2.1.1	Output Phase Relationships	20
2.1.2	Star-connected loads	21
2.1.3	Three phase loads with isolated elements	22
2.1.4	Current Injection Procedure (No Timing)	22
2.2	Timing System	23
2.2.1	General Procedure for Timing Tests	23
2.2.2	Timer Mode: Off	23
2.2.3	Timer Mode: Internal Start	24
2.2.4	Timer Mode: Single Contact	24
2.2.5	Timer Mode: Dual Contact	24

2.2.6	Timer Mode: Current Operated	24
2.2.7	Timer Mode: Pulse	25
2.3	Auxiliary Metering Inputs	25
2.3.1	Voltage Measurement	25
2.3.2	Current Measurement	25
2.3.3	Frequency Measurement	25
2.3.4	Phase Measurement	26
2.4	Auxiliary AC Supply	28
3	APPLICATION NOTES – TESTING SPECIFIC DEVICES	29
3.1	Three Phase Over Current Relays	29
3.1.1	Connections	29
3.1.2	Test procedure	29
3.2	Timing of Auto-Reset/Reclosing Devices	31
3.2.1	Connections	31
3.2.2	Test procedure	31
3.3	Timing Circuit Breakers	32
3.3.1	Connections	32
3.3.2	Test procedure	32
3.3.3	Devices with short trip times	33
3.4	Directional relays (in conjunction with DVS3 voltage source)	34
3.4.1	Connections	35
3.4.2	Test procedure – restraint angle	35
3.4.3	Test procedure – overcurrent timing	36
4.	MAINTENANCE	37
4.1	Regulator Brushes	37
4.2	Removal of the 50A-3PH mk2 from Case	37
5.	STANDARD ACCESSORIES	38
5.1.	Spares fuses supplied:-	38
5.2.	Standard Accessories Supplied	38

6.	OPTIONAL DELTA-STAR TRANSFORMER	39
6.1	Description	39
6.1.1	Front Panel Layout	40
6.1.2	Electrical Specification	41
6.2	Operation	42
6.2.1	Supply Voltage Connections	42
6.2.2	Connections between units	43
7.	OVERALL PERFORMANCE SPECIFICATION	44
7.1.	Insulation Resistance at 1000V DC	44
7.2.	Applied Voltage Test	44
7.3.	Accuracy of Instrumentation and associated circuit components	44
7.3.1	Main Output Ammeter	44
7.3.2	Auxiliary Metering	44
7.3.3.	Timing System	44
8.	REVISION	45

1. DESCRIPTION OF EQUIPMENT

The 50A-3PH mk2 is a flexible 3 phase current injection system capable of supplying currents of up to 50A ac per phase into a variety of loads. The unit is designed for testing devices used for power system protection, but can be used wherever a 3 phase high current AC source is required. The outputs may also be used in voltage mode to supply voltages of up to 18Vac.

An independently isolated output is provided for each phase, allowing a wide range of output configurations to be selected.

Accurate metering facilities with a fast capture time and a very flexible timing system are provided. A single phase isolated auxiliary AC output is also available.

The unit also has an auxiliary metering input, allowing the measurement of voltage, current, frequency, and phase.

The 50A-3PH mk2 requires a 3 phase 4 wire 400V supply (400V version) or a 3 phase 3 wire 220V supply (220V version), but an optional delta-star converter is available, allowing the 400V 50A-3PH mk2 to be operated from 115V, 230V, 400V or 440V three wire supplies. The supply voltage of the unit is identified on the front panel.

The 50A-3PH mk2 is designed to be used on 'dead' systems (i.e. no externally supplied voltages are present on the test object). Under no conditions connect the 50A-3PH mk2 to a live system. Always check that the power to the device under test is off and the circuit is isolated before making any connections.

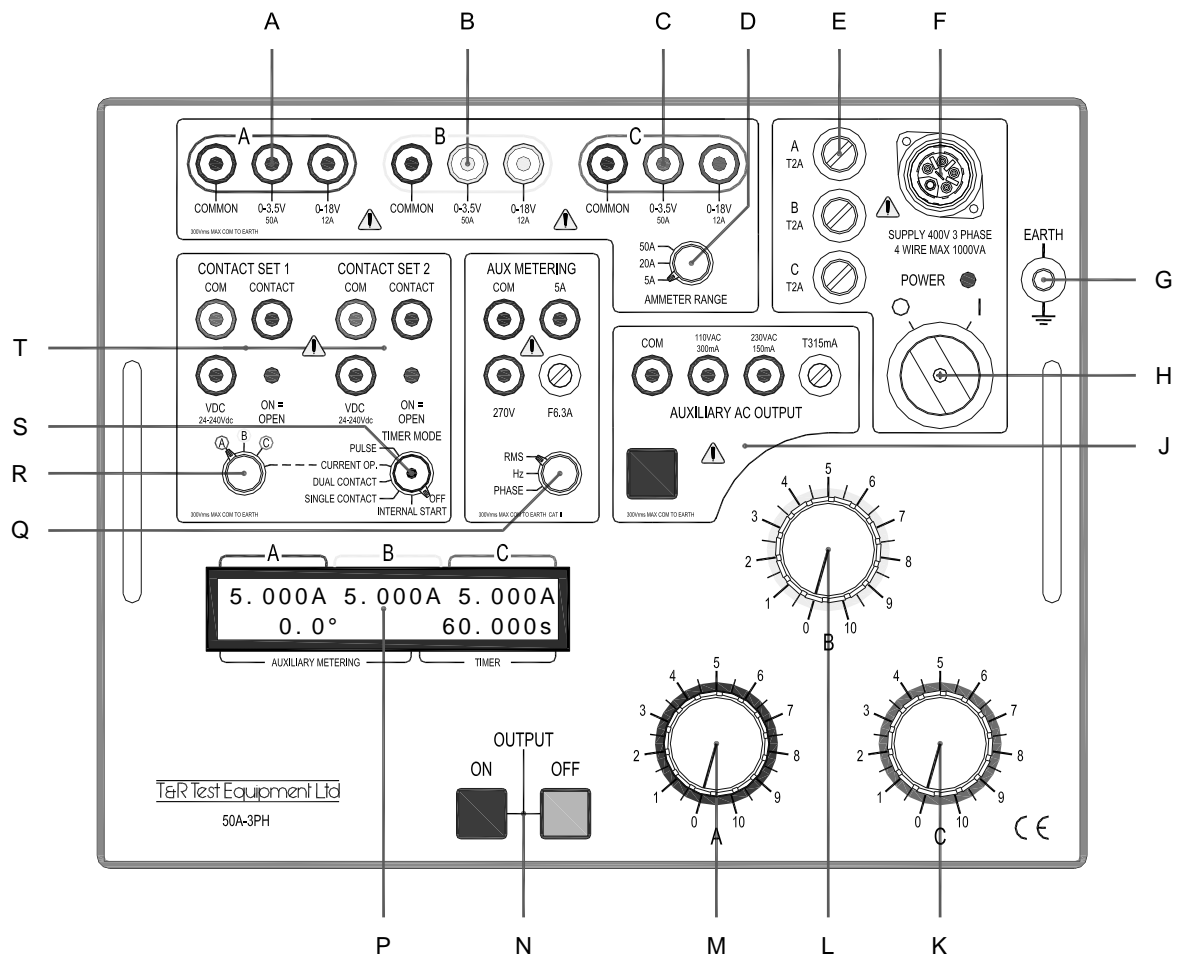

1.1 Front Panel Layout

Ref	Item	Function
A	Main output – phase A	Phase A current output
B	Main output – phase B	Phase B current output
C	Main output – phase C	Phase C current output
D	Ammeter range switch	Selects ammeter range for main outputs
E	Mains input fuses	
F	Mains input connector	
G	Earth terminal	Connect to local ground for safety
H	Mains on/off switch	
J	Auxiliary ac voltage output	Single phase 115V/230V isolated output
K-M	Main output controls	Control main current output level
N	Main output on/off controls	Switches the main outputs on & off
P	Display	Shows current, time, aux input & status
Q	Auxiliary metering select	Selects auxiliary input function
R	Phase selector switch	Selects phase for current operated mode and phase angle measurement
S	Timer mode switch	Selects timer mode
T	Timer contact sockets	Contact inputs for timer
U	Auxiliary metering sockets	Auxiliary metering input sockets

1.2 Installation

1.2.1 Environment

The 50A-3PH mk2 is designed for use in indoor industrial and electrical substation environments.

Maximum altitude: 2000m

Temperature: 0°C to 45°C operating
-20°C to 60°C storage

Relative humidity: 90% non-condensing

Protection rating: IP40 lid closed
IP20 in use



WARNING

In substation environments the earth terminal on the front panel of the unit should be connected to a low impedance local earth.



WARNING

Ensure that the unit is connected to an appropriate supply by a suitably rated connector.

1.2.2 Supply Requirements

1.2.2.1 400V 4 wire supply version

The 50A-3PH mk2 400V version requires a three phase 4 wire 50/60Hz supply of 400V-10%+14%. The maximum power requirement of the unit is 1000VA.

Other supply voltages may be catered for by using the optional 50A-3PH mk2 Delta-Star converter. This allows the 400V unit to operate from 3 wire supplies of 115V, 230V, 400V or 440V (see section 6).

1.2.2.2 220V 3 wire supply version

The 50A-3PH mk2 requires a three phase 3 wire (delta) 50/60Hz supply of 220V-10%+14%. The maximum power requirement of the unit is 1000VA.

1.2.3 Supply Voltage Connections

The 50A-3PH mk2 is supplied with a five core supply cable with a CEE 400V 16A 3P+N+E 5 pin plug fitted. If this connector is not correct for the supply environment an adaptor should be used.

If necessary the supply plug can be changed. Ensure that the plug is connected correctly. The cores of the supply cable are marked to ensure correct phase rotation. The mains input lead is marked as follows:

L1	Brown
L2	Black
L3	Grey
Neutral	Blue
Earth	Green and yellow

The 400V version requires a neutral connection (4 wire supply), and will not operate from a three wire supply without the optional 50A-3PH mk2 delta-star converter.



Ensure that the unit is connected to an appropriate supply by a suitably rated connector.

WARNING

The 220V version does not require a neutral connection, and the neutral is not connected inside the unit. The neutral connection in the mains lead should be cut off.

It is essential that this unit is earthed.

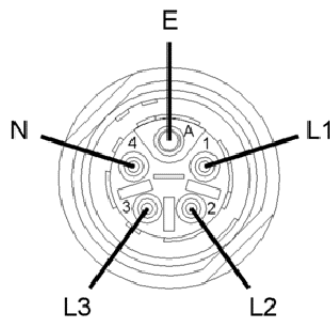

Figure 2.1 Connections for mains input socket

1.2.3.1 Operation from a Single Phase Supply

If no three phase supply is available, it is possible to operate the 400V 50A-3PH mk2 from a single phase supply with reduced functionality. When operating from a single phase supply, all three outputs will be IN PHASE.

To connect the set to operate from a three phase supply, connect L1, L2 and L3 to live, and N to neutral.

The 220V three wire unit **MUST NOT** be supplied from a single phase supply.

1.3 Functions

1.3.1 Main Current Outputs

The main current output of the unit consists of three independent, isolated outputs derived from the three mains phases. The phase difference between the outputs is therefore fixed at 120°. Each output is independently controllable.

Each of the main outputs has two taps, allowing voltage ranges of 0-3.5V or 0-18V to be selected. The ratings of each tap are shown in the table below.

Voltage range	Current rating		
	Continuous	5min on/15 off	1min on/15 off
0-3.5V	16A	32A	50A
0-18V	4A	8A	12A

Each output is rated for a continuous current, and for higher intermittent currents. The maximum 'on' time for intermittent currents is enforced by the unit, and the output will be switched off if the rating is exceeded. The display will then show the following message until the green 'off' button is pressed to clear the trip condition:



```
Output Tripped
Press Green to Reset
```

The outputs are rated for a maximum of three times the rated continuous current for 1 minute on and 15 minutes off. The complete curve for intermittent current ratings is shown in figure 1.1.

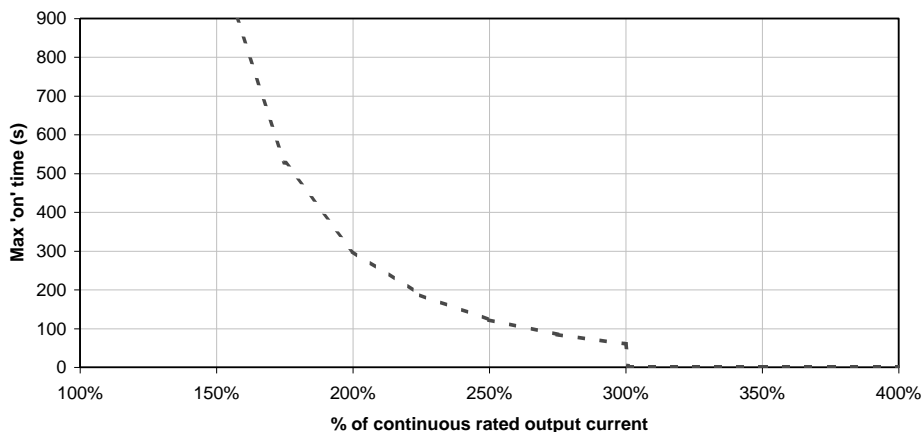

Figure 1.1 50A-3PH mk2 maximum 'on' times

1.3.2 Current Metering

The main output currents are metered by a true RMS reading digital memory ammeter. The following ranges are available:

Range	Resolution	Accuracy	Trip current
5.000A	0.001A	±0.6% rdg ±5d	5.25A
20.00A	0.01A	±0.6% rdg ±5d	21.0A
50.00A	0.01A	±0.6% rdg ±5d	52.5A

The ammeter range is independent of the current output selected, and is therefore possible to meter low currents very accurately from the lower voltage range. This allows the lowest possible voltage tap to be selected at all times, which gives the best control of the output current.

The unit has an electronic trip circuit that monitors the output current and switches the output off if the trip value exceeds 105% of full scale of the metering range selected.

1.3.3 Auxiliary AC Voltage Output

The auxiliary AC voltage output has two ranges, selected using the output sockets. Under no condition should connections be made to both ranges at the same time. The output is switched independently of the main output. The voltage and current from this output may be metered using the auxiliary metering input.

Range	Maximum VA	Maximum Current
110V	33VA	300mA
230V	35VA	150mA

1.3.4 Auxiliary Metering Input

The 50A-3PH mk2 has an auxiliary metering input which can be used to measure AC voltage or current, frequency, and the phase between the main output and the auxiliary input. The unit may measure either voltage or current derived quantities by selecting the appropriate input on the front panel.

The following ranges are provided:

	Range	Resolution	Accuracy
AC voltage	0-270.0Vac rms	0.1V	±0.7% rdg ±5d
AC current	0-5.000Aac rms	0.001A	±0.7% rdg ±5d
Frequency (V)	40.00-99.99Hz	0.01Hz	±0.2% rdg ±2d
Frequency (I)	40.00-99.99Hz	0.01Hz	±0.2% rdg ±2d
Phase (V)	±180.0°	0.1°	±3 degrees
Phase (I)	±180.0°	0.1°	±3 degrees

The phase measurement range measures the phase between the main current output selected by the phase select switch and either the voltage or current input. In each case, the current or voltage must be greater than 0.5% of the full scale of the range for the phase to be displayed and more than 10% for the stated accuracy to be guaranteed.

1.3.5 Timing System Specification

The 50A-3PH mk2 is fitted with an integrated timing system that is linked to the main output and two sets of contact inputs. The system is highly flexible, and allows for the timing of all common protection devices and trips. The timer may also be used to time external events not linked to the output of the set.

Full details of operating the timer are given in section 2.

Timer information

Timer range	0-999.999s/9999.99s/99999.9s auto-ranging
Resolution	1ms/10ms/100ms
Accuracy	$\pm 0.01\%$ rdg $\pm 2d$ All modes except current operated $\pm 0.01\%$ rdg $\pm 4d$ Current operated mode
Contact o/c voltage	24V
Contact s/c current	20mA
Contact indication	LED on – contact open LED off – contact closed

Timer Modes

Timer Mode	Timer Start Condition	Timer Stop Condition	Automatic output off	Example application
Off	-	-	-	Set current
Internal Start	Main output on	C1 change	When timer stops	IDMT relay
1 Contact using Contact 1	C1 1st change	C1 2nd change	C1 1st change (timer start)	Auto-recloser
1 Contact using Contact 2	C2 1st change	C2 2nd change	C2 2nd change (timer stop)	Drop-off timing
2 Contacts 1st change C1	C1 change	C2 change	C2 change (timer stop)	
2 Contacts 1st change C2	C2 change	C1 change	C2 change (timer start)	Auto-reclose relay
Current Operated*	Current >20% of range on selected phase	Current >20% of range on selected phase	Timer stop	Miniature circuit breakers
Pulse	Main output on	200ms	200ms	Set current for thermal devices

* results obtained with test currents below 20% of range will give a lower accuracy than specified.

1.3.6 **Contact Inputs**

The 50A-3PH mk2 has two contact inputs which are used to start and stop the timer depending on the mode selected. Each input has a connection for volt-free contacts and for triggering by a DC voltage. In each case, the input auto-selects for normally open or normally closed contacts. The contact state is shown by an LED, which is off when the contact is closed, and on when the contact is open.

The maximum open circuit voltage across the contact input is 24V, and the short circuit current through the contacts is limited to 20mA.

1.3.7 **Vdc Contact Input**

The Vdc contact input is triggered by a change of state of an external DC voltage. It is triggered by voltages in the range 24-240Vdc. Either a change from zero to 24-240V or a change from 24-240V to zero will trigger the timer. The negative of the signal is connected to the blue "Com" socket and the positive is connected to the red "Vdc socket".



WARNING

When making connections ensure that the circuit under test is dead and earthed (i.e. no voltages are present). Ensure that the 240Vdc maximum for the input is not exceeded.

1.4 Displayed Values and Messages

1.4.1 Displayed Values

The 50A-3PH mk2 display simultaneously shows the three injected test currents, the timer result, the selected auxiliary input value and quantity, and the state of the output on a liquid crystal display. It also displays warning and error messages, detailed in section 1.2.2.

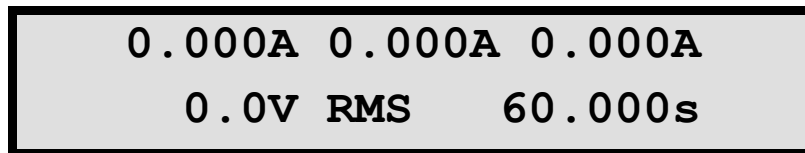

0.000A 0.000A 0.000A
0.0V RMS 60.000s

Figure 1.2 Normal values displayed on screen

1.4.2 Warning Messages

In addition to the normal display screens, the 50A-3PH mk2 can display a range of warning messages if the unit trips on over-current or duty cycle or is too hot internally. If an over current or duty cycle trip occurs, the green 'off' pushbutton must be pressed to clear the trip condition. If the unit trips on over temperature, the unit will automatically reset when the temperature falls to an acceptable level. If the unit is over temperature, switching the unit off and back on will not clear the message – the unit must be allowed to cool.

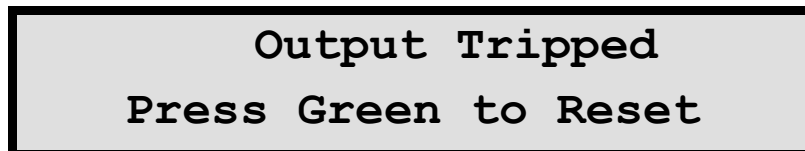

Output Tripped
Press Green to Reset

Figure 1.3 Over-current trip warning message

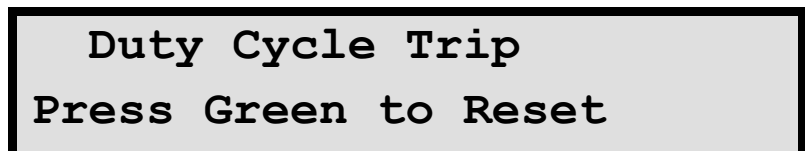

Duty Cycle Trip
Press Green to Reset

Figure 1.4 Duty cycle trip warning message

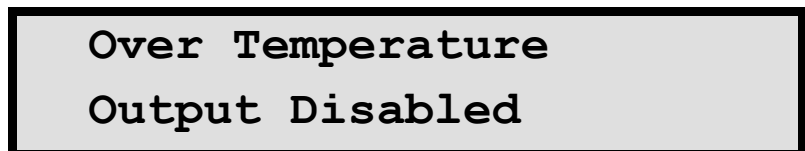

Over Temperature
Output Disabled

Figure 1.5 Unit over temperature warning message

1.5 Overload Protection

The 50A-3PH mk2 is fitted with a range of over protection devices, listed in the table below.

Location	Protection
Mains supply	T2A fuses on each phase
Auxiliary ac output	T315mA fuse
Contact circuits	Auto-resetting semiconductor fuses
Main output	Electronic over-current trip Electronic duty cycle trip Thermal protection
Auxiliary metering current input	F6.3A fuse

2. OPERATION

This chapter describes how to use the different outputs and timing modes on the 50A-3PH mk2. Details of testing specific relay types are given in the application notes section of this manual.

2.1 Main Output Connection

The main output on the 50A-3PH mk2 is used to inject current into test object to determine operating (setting) levels and trip times. The outputs are taken from the 'main output' terminal groups. For each phase two outputs are available for AC injection (of which only ONE may be used at any one time). The outputs are switched on and off using the "output on" and "output off" pushbuttons, and the voltages of each phase (and hence current) are set using the "A", "B", and "C" control knobs.

Two outputs are provided for each phase to allow a wide range of currents to be injected into a wide range of load impedances. The output voltages and current available are shown in the table below:

Voltage range	Current rating		
	Continuous	5min on/15 off	1min on/15 off
0-3.5V	16A	32A	50A
0-18V	4A	8A	12A

A true RMS ammeter with 5, 20 and 50A ranges meters the output current. The meter range is totally independent of the output tap, allowing any metering range to be used with either of the output taps.

It is important to understand that the best current control is obtained by selecting the LOWEST possible VOLTAGE range on the set to achieve the required current. It is always best to start by connecting the device under test to the 3.5V output (as shown in Figure 2.1), and selecting the lowest current metering range that includes the desired test current. It may seem counter-intuitive to connect a 1A relay to the terminal marked "50A", but it will give the finest current control.

Most electronic and microprocessor relays have a very low impedance, and the 3.5V tap is almost always the most suitable to test these relays. Electro-mechanical relays may require the use of the higher voltage tap, as these have a higher impedance.

2.1.1 Output Phase Relationships

The phase relationship between the supply voltages and the output voltages are shown below. The phase relationship between the output voltage and output current is determined by the impedance of the load.

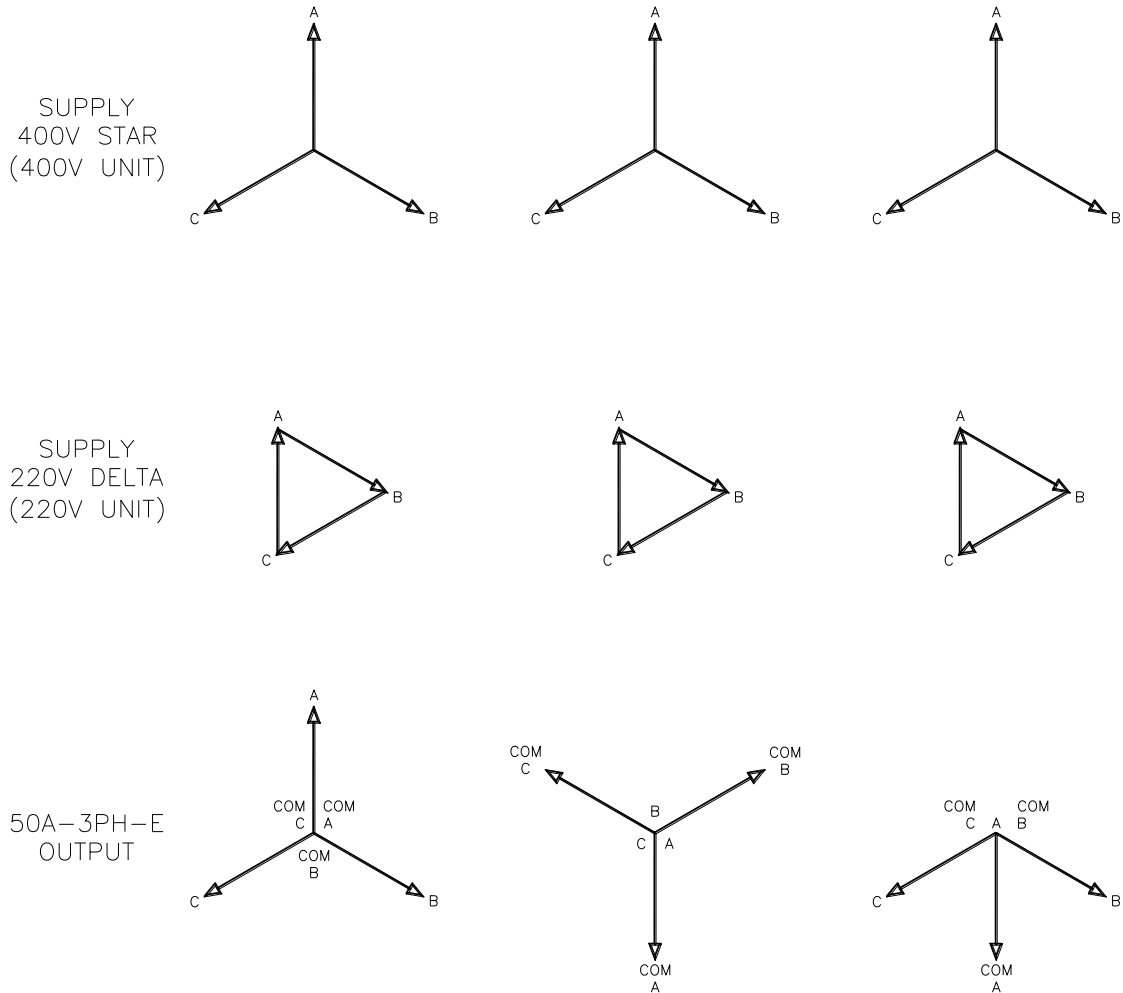

Figure 2.2 Supply and output phase relationships

Note that any phase can be shifted by 180° by reversing the connections for that phase. Equal currents are shown in the phasor diagrams above, but unequal currents are equally valid.

Delta output connections are not valid.

2.1.2 Star-connected loads

The configuration and interconnection of the outputs depends on the configuration of the load. The configuration for injecting current into a three phase star-connected load is shown in figure 2.3.

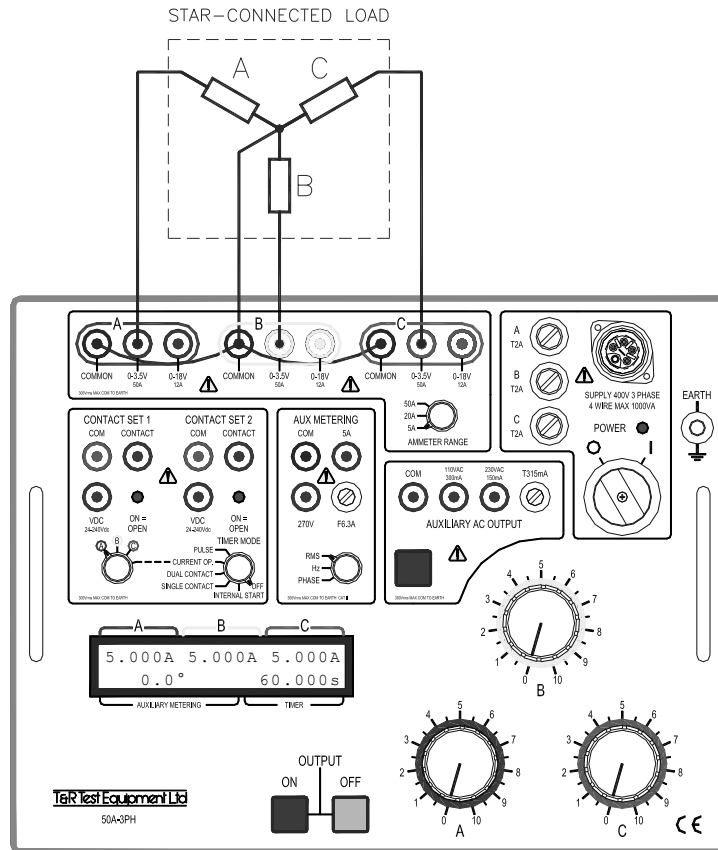

Figure 2.3 Connections for star-connected load

2.1.3 Three phase loads with isolated elements

It is also possible to inject current into three isolated loads, as occurs on some relays and three phase MCBs. See figure 2.4.

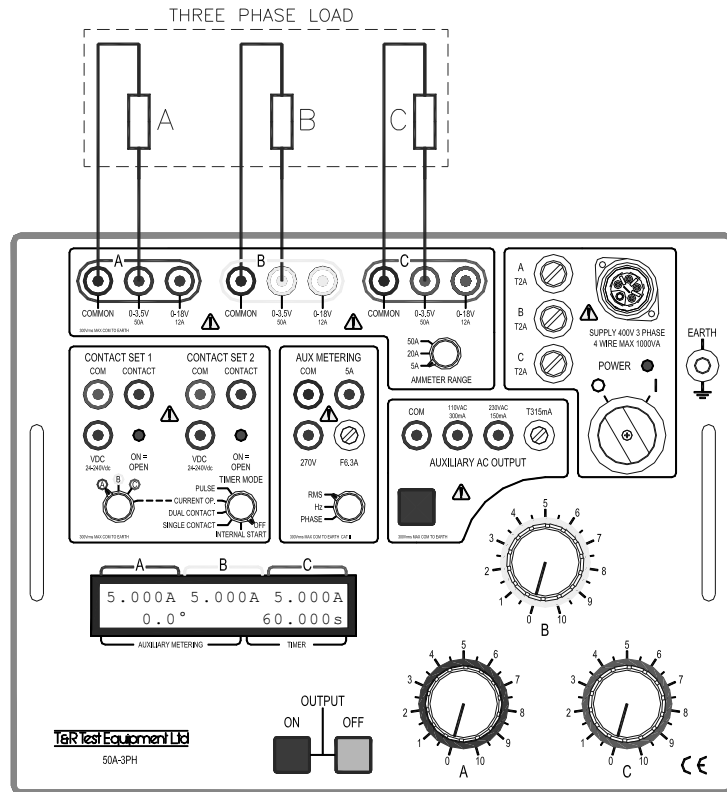

Figure 2.4 Connections for load with isolated elements

2.1.4 Current Injection Procedure (No Timing)

- Connect the test object to the desired output. An example connection is shown in figure 2.3 using the 0-3.5V output.
- Set the “AMMETER RANGE” switch to a suitable setting.
- Set the output controls to zero, and the timer mode switch to “Off”.
- Switch the output on using the “OUTPUT ON” pushbutton, and increase the test current in each phase to the desired level using the output controls A, B, and C.
- Switch the output off using the “OUTPUT OFF” pushbutton.

2.2 Timing System

The 50A-3PH mk2 timer is very flexible, and is closely integrated with the main output. A summary of the start and stop events for the timer is shown in the table below.

Timer Mode	Timer Start Condition	Timer Stop Condition
Off	-	-
Internal Start	Main output on	C1 change
1 Contact using Contact 1	C1 1st change	C1 2nd change
1 Contact using Contact 2	C2 1st change	C2 2nd change
2 Contacts 1st change C1	C1 change	C2 change
2 Contacts 1st change C2	C2 change	C1 change
Current Operated*	Current >20% of range on selected phase	Current >20% of range on selected phase
Pulse	Main output on	200ms

The timer is automatically reset in every mode when the output is switched on. In each mode that the timer is active, the output of the unit must be switched on to arm the timer.

Each contact channel has a contact input for volt-free contacts and a Vdc input for dc voltages. The Vdc input may be used to trigger the timer from a dc voltage, and will trigger from either the voltage switching from zero to 24-240Vdc or 24-240Vdc to zero. The voltage must be connected with positive to the red "Vdc" terminal and negative to the blue "com" terminal.

2.2.1 General Procedure for Timing Tests

To time the operation of any device a basic procedure needs to be followed to set the desired test current and to carry out the timing test.

- Connect the device under test to the output of the unit and to the contact inputs as required. For details of connection configurations, see the applications notes section.
- Set the timer to 'off' mode and the output control to zero. Switch on the output of the unit, and increase the current of each phase to the desired level.
- Switch off the output of the unit and select the desired timer mode.
- Switch on the output of the unit. The timer will reset, and start when the start condition is met.
- The timer will stop when the stop condition is met.

2.2.2 Timer Mode: Off

In the 'off' mode, the timer has no effect on the operation of the set, and the timer does not run. This mode is used to set the required current through the test object before a timing test.

2.2.3 Timer Mode: Internal Start

The internal start mode starts the timer when the main output is switched on, and stops the timer on the first change of contact set 1. When the timer is stopped, the output of the unit is automatically switched off.

2.2.4 Timer Mode: Single Contact

In single contact mode, the timer starts on the first change of state of contact set 1 after the output is switched on, and stops on the second change on contact set 1. The output is automatically switched off when the timer is started. The timer is reset when the output is switched on. This timer mode is ideally suited to timing auto-reclose relays.

If a single contact mode is required where the output remains on until the second change of contact, this may be achieved by using single contact mode with contact set 2.

2.2.5 Timer Mode: Dual Contact

Dual contact mode uses both contact set 1 and contact set 2. The time between C1 and C2 changing is always measured whether C1 or C2 changes first. If C1 changes first, the output switches off when the timer stops. If C2 changes first, the output switches off when the timer starts. In dual contact mode the timer will initially start when the output is switched on, but will restart on the first contact change.

2.2.6 Timer Mode: Current Operated

Current operated mode is used to time devices that have contacts in series with the current sense element. This includes miniature circuit breakers and MCBs.

Only one phase is timed on the 50A-3PH mk2 when current operated mode is selected. The phase to be timed is selected using the phase select switch.

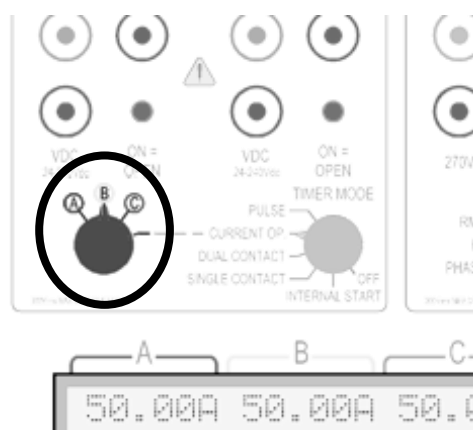

Figure 2.5 Phase select switch

The timer is started when the output current exceeds 20% of full scale of the selected metering range, and stops when the current falls below this threshold.

2.2.7 *Timer Mode: Pulse*

The pulse mode is used to set the current in devices that are sensitive to heating due to the test current. In this mode current is injected for 200ms when the on switch is pressed. The current is captured and displayed.

2.3 Auxiliary Metering Inputs

The 50A-3PH mk2 is fitted with an auxiliary metering circuit to measure external voltages, currents, frequency and phase angles. Two inputs are provided, one for voltages up to 270V and the other for currents up to 5A. The input in use is automatically selected by the unit. DO NOT connect to both of the inputs simultaneously.

2.3.1 *Voltage Measurement*

To measure external voltages, connect the signal to the aux metering terminals marked 'COM' and '270V'. Ensure that the voltage to be measured is switched OFF when connecting the leads.

The type of reading to be taken should then be selected using the aux metering rotary selection switch. The frequency of the signal and phase relative to the main output current may also be measured.

When measuring voltages, ensure that 270V ac is not exceeded on the 270V terminal.

2.3.2 *Current Measurement*

To measure current, connect to the 'COM' and '5A' aux metering sockets. The aux metering rotary switch selects the reading type.

2.3.3 *Frequency Measurement*

The frequency of the input signal may be measured for either a voltage or current input. To measure frequency, the voltage or current must 0.15V or 0.025A respectively.

2.3.4 Phase Measurement

The 50A-3PH mk2 auxiliary metering circuit may be used to measure the phase difference between one of the phases of the main output current and the auxiliary metering input.

2.3.4.1 Phase measurement between output current and an external voltage

Certain relays and transducers require the injection of a current and the application of a phase-shifted voltage (e.g. directional relays). In such situations, the auxiliary metering circuit may be used to measure the phase angle between the 50A-3PH mk2 output current and an externally generated phase-shifted voltage. The circuit configuration is shown below using a T&R Test Equipment DVS3 mk2 voltage source. The aux metering mode switch should be set to “phase”.

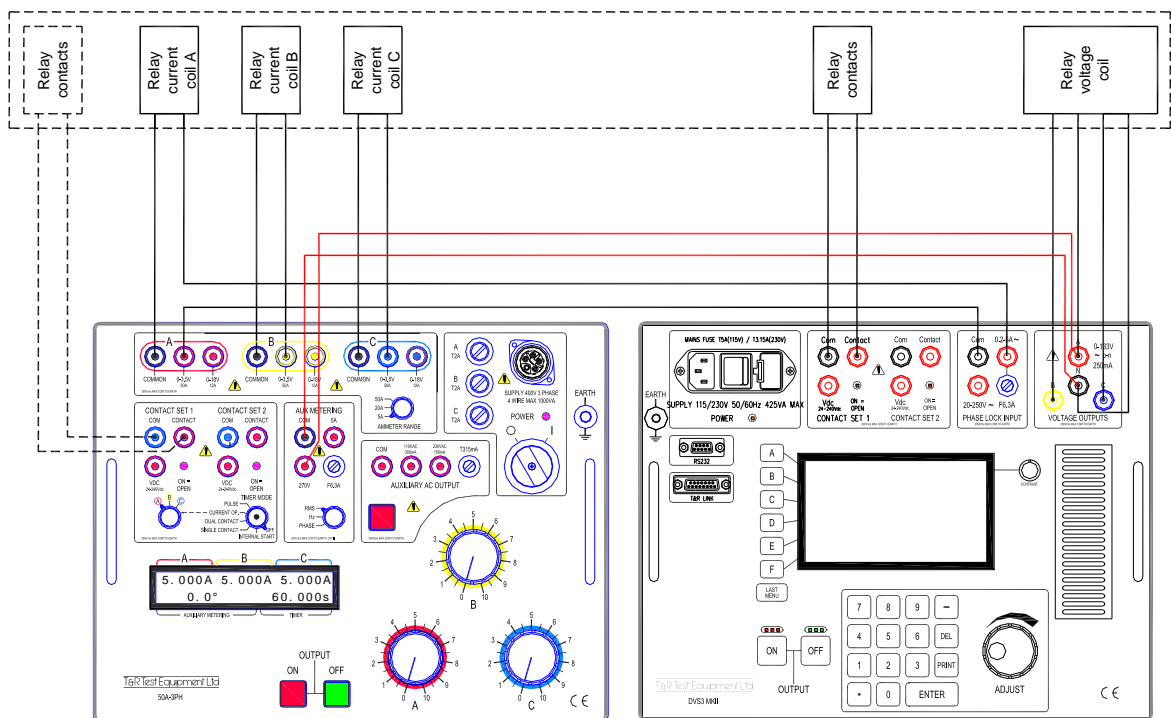

Figure 2.6 Phase measurement

When measuring the phase angle between the output current and an external voltage, the 50A-3PH mk2 defines the voltage generated across a resistive load an output as in phase with the current. Connecting a resistor as shown in figure 2.7 will therefore result in a voltage in phase with the output current from phase A.

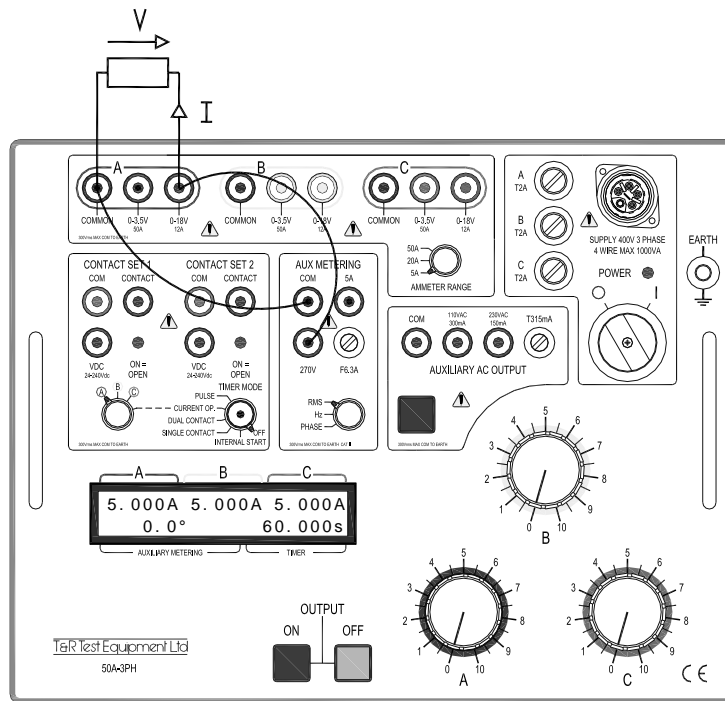

Figure 2.7 Zero phase between voltage and current

2.3.4.2 Phase measurement between output current and an external current

The auxiliary current input can be used to measure the phase of an external current (up to 5A) relative to the output current from phase A, B or C. To do this, connect the external current to the aux metering “com” and “5A” terminals, and switch the mode switch to “phase”. Select the desired reference phase output using the phase select switch.

The connection shown below will result in a measured angle of zero degrees. Note that the phase select switch is set to phase A.

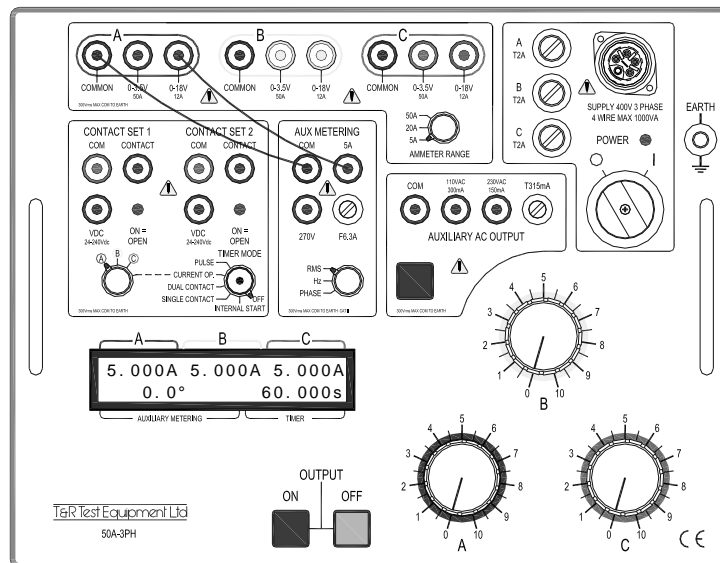

Figure 2.8 Zero phase between internal and external current

2.4 Auxiliary AC Supply

The auxiliary AC voltage output has two ranges, 110V and 230V, selected using the output sockets. Under no condition should connections be made to both ranges at the same time. The output is switched independently of the main output. The voltage/current from this output may be metered using the auxiliary metering input.

Range	Maximum VA	Maximum Current
110V	33VA	300mA
230V	35VA	150mA

The output from the auxiliary supply is nominally in phase with the phase A output voltage.

3 APPLICATION NOTES – TESTING SPECIFIC DEVICES

This chapter gives details of how to test many common types of protection device using the 50A-3PH mk2.

3.1 Three Phase Over Current Relays

The configuration shown in figure 3.1 is suitable for testing over-current relays, and will measure the time delay between the time when the “on” pushbutton is pressed and the time the relay trips.

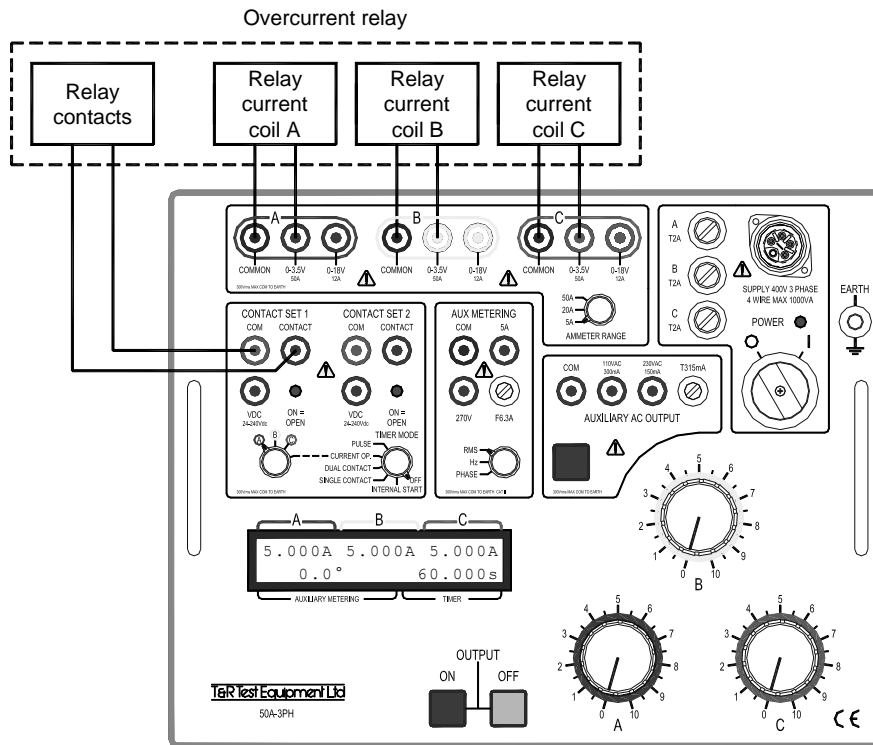

Figure 3.1 Connections for testing over-current relays

3.1.1 Connections

Ensure that the output is switched off and that the relay is isolated before making any connections.

Connect the relay contacts to contact set 1.

Connect the relay current coils to the 3.5V outputs, selecting suitable leads from the lead set depending on the current to be injected. If the desired current is unobtainable during testing, it may be necessary to connect the relay coils to the higher voltage tap on the 50A-3PH mk2.

3.1.2 Test procedure

Set the output controls to zero (anti-clockwise) and the timer mode to “off”.

Select the desired ammeter range.

Press the “output on” pushbutton and increase the desired test current for each phase.

Switch the output off using the “output off” pushbutton.

Select “internal start” timer mode, and switch the output on. The unit now resets and starts the timer and starts injecting current into the relay. When the relay’s contacts change state, the timer will stop and the output will be switched off automatically.

3.2 Timing of Auto-Reset/Reclosing Devices

Auto-reclosing devices require that the timer is started when power is removed from the device, and the timer stops when the contacts change state. This may be achieved using the single contact timer mode using contact set 1.

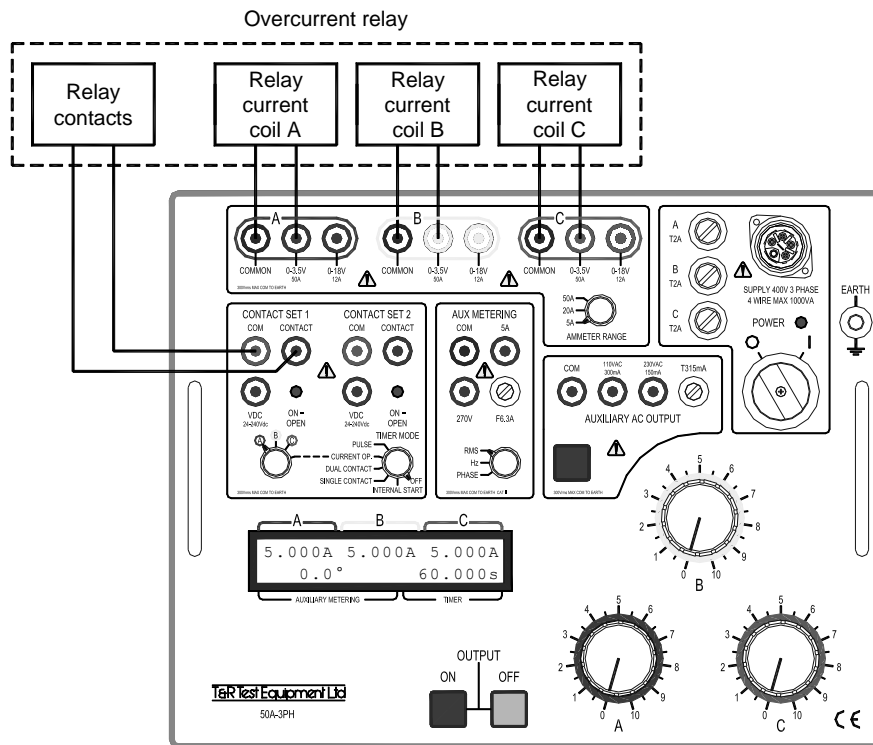

Figure 3.2 Connections for testing auto-reclose devices

3.2.1 Connections

Ensure that the outputs are switched off and that the relay is isolated before making any connections.

Connect the relay contacts to contact set 1.

Connect the main outputs as shown in figure 3.2, selecting the most appropriate output taps for the relay under test.

3.2.2 Test procedure

Set the main output controls to zero (anti-clockwise) and the timer mode to “off”.

Switch on the main output, and increase the currents for each phase to the desired level.

Switch off the main output.

Switch the timer to “single contact” mode, and reset the relay.

Switch the main output on. The output will be switched off and the timer will start when the relay trips. The timer will stop when the relay auto-recloses.

3.3 Timing Circuit Breakers

Testing CBE's MCB's and other devices with no auxiliary contacts is possible using the current operated timer mode on the 50A-3PH mk2. This mode starts the timer when the output current on the selected phase exceeds 20% of the selected current range, and stops the timer when the current on the selected phase falls below 20% of range. The phase on which to start and stop the timer is selected using the phase select switch.

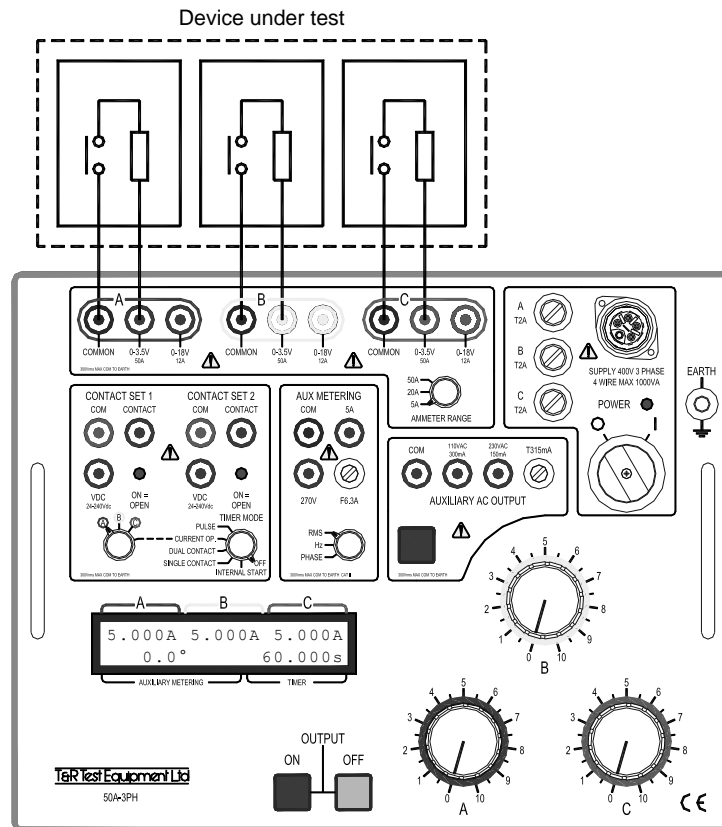

Figure 3.3 Connections for testing circuit breakers

3.3.1 Connections

Ensure that the outputs are switched off and that the device under test is isolated before making any connections.

Connect the main outputs as shown in figure 3.4, selecting the most appropriate tap for the device under test. For circuit breakers and other current trips, this will almost always be the 0-3.5V output.

Set the ammeter switch to the most suitable range.

Set the phase select switch to trigger the timer on the desired phase.

3.3.2 Test procedure

Set the output controls to zero (anti-clockwise) and the timer mode to "off".

Switch on the main output, and increase the outputs to the desired level.

Switch off the main output.

Switch the timer to “current operated” mode, and reset the breaker if it has tripped.

Switch the main output on. The timer will start when current starts flowing in the device under test, and will stop when the device trips.

3.3.3 *Devices with short trip times*

When testing devices with short trip times (such as thermal circuit breakers at high over-current factors), setting the current may cause the breaker to trip. In such circumstances, set the current using pulse mode. In this mode, current will be injected for 200ms and the current logged every time the “output on” button is pressed.

3.4 Directional relays (in conjunction with DVS3 voltage source)

Directional relays may be tested using the 50A-3PH mk2 in conjunction with a suitable voltage source (such as the T&R DVS3). This procedure will detail the test procedure using the DVS3, but may be adapted to other voltage sources.

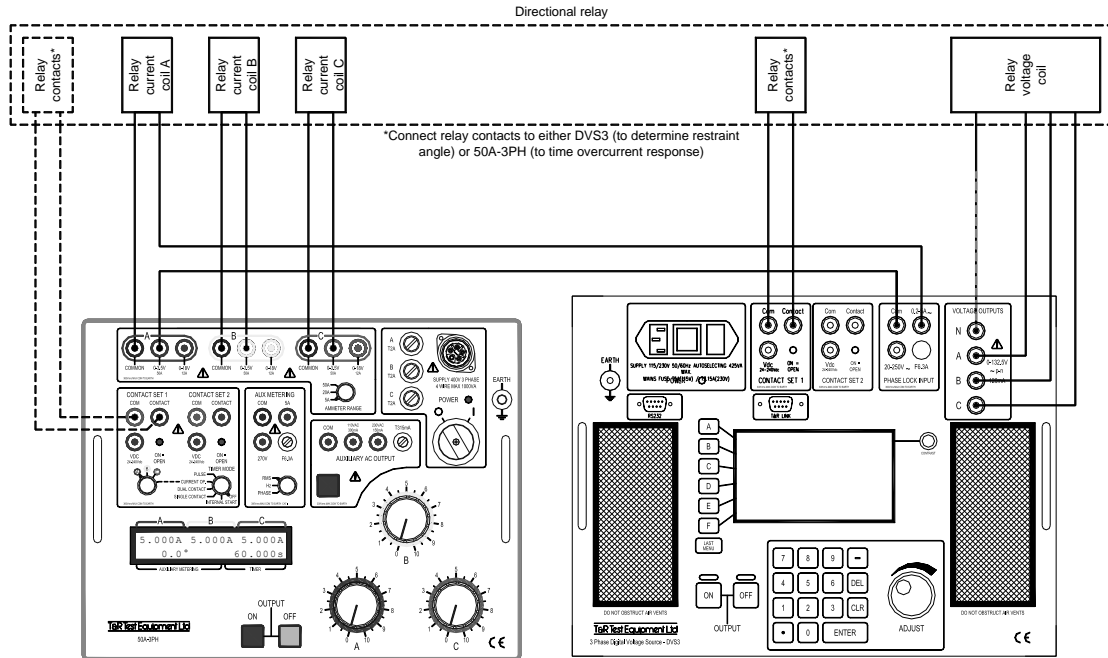

Figure 3.4 Connections for directional overcurrent relay

The phase locking between a 50A-3PH mk2 and a DVS3 mk2 may be simplified considerably using the T&R link phase locking lead as shown in figure 3.5.

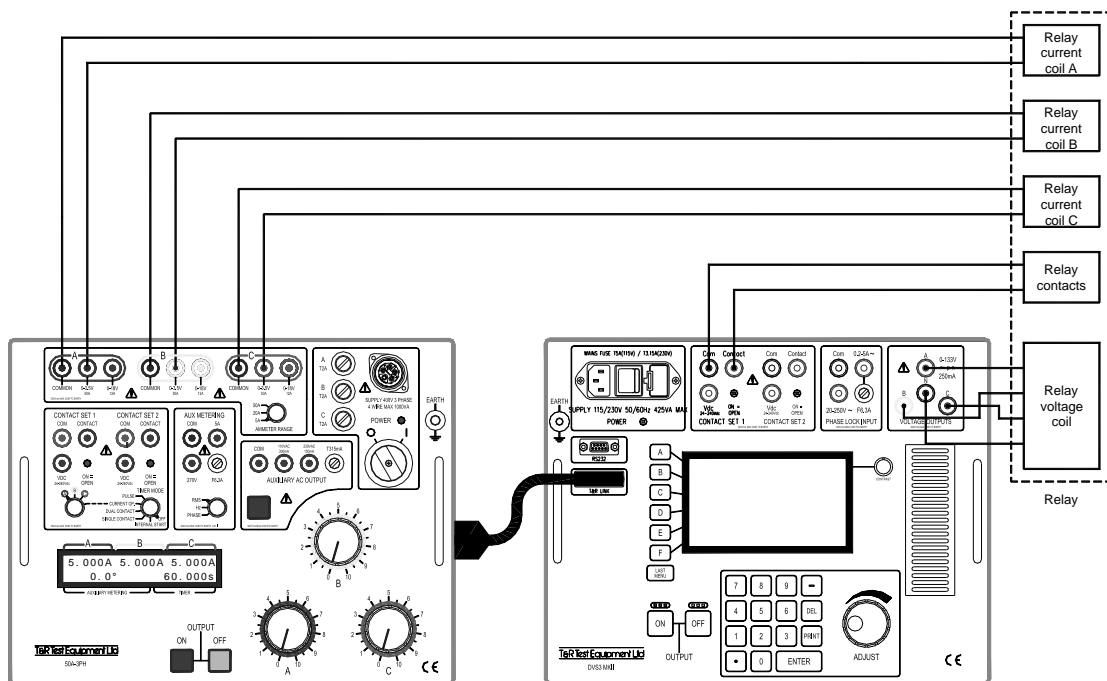

Figure 3.5 Connections for directional overcurrent relay using T&R Link phase locking

3.4.1 Connections

Ensure that the outputs are switched off and that the device under test is isolated before making any connections.

Connect the main outputs to the relay current coils as shown in figure 3.5, selecting the most appropriate tap for the device under test. The output of phase A is looped into the DVS3 phase lock input to allow the DVS3 to phase lock to the current output of the 50A-3PH mk2.

Connect the output from the DVS3 to the relay voltage coils.

Set the ammeter switch to the 5A range, and the phase select switch to phase A.

Phase A of the DVS3 may be connected to the auxiliary input of the 50A-3PH mk2 as a double-check on the phase angle if required (not shown in figure 3.4 for clarity – refer to figure 2.6 for connections).

Connect the relay contacts to contacts set 1 on the DVS3.

3.4.2 Test procedure – restraint angle

Set the output controls to zero (anti-clockwise) and the timer mode to “off”.

Switch on the main output, and increase the output current for each phase to the setting current of the relay.

Select “Phase lock” mode on the DVS3, and select the lock source as “External lock”. Set the DVS3 to the desired output voltage, and switch the DVS3 output on.

When phase A on the DVS3 is set to zero, the voltage from the DVS3 will be in phase with the current from the 50A-3PH mk2. The phase angle between the current and voltage may now be altered using the phase control on the DVS3. The contacts on the relay will now change state (indicated on the DVS3 screen) as the voltage phase is rotated through the restraint angle of the relay.

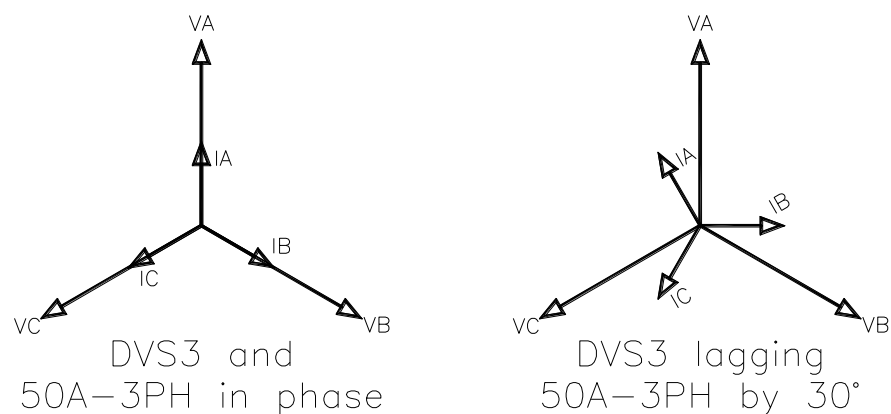

Figure 3.6 50A-3PH mk2 and DVS3 output phasors

3.4.3 Test procedure – overcurrent timing

Ensure that the outputs are switched off and that the device under test is isolated before making any connections.

Disconnect the relay contacts from the DVS3 and connect to contact set 1 on the 50A-3PH mk2 (see figure 3.7).

Disconnect the 50A-3PH mk2 phase A from the DVS3 (this may be left connected if the test current will not exceed 5A or if using the T&R Link phase lock connection between a 50A-3PH mk2 and DVS3 mk2.).

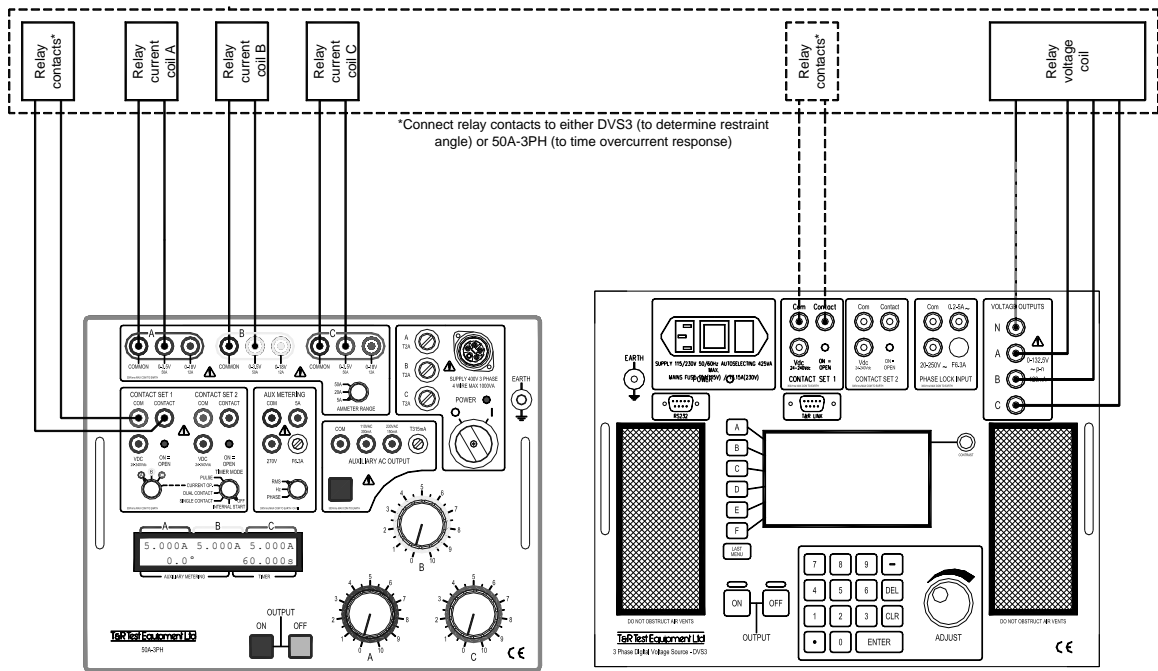

Figure 3.7 Connections for current injection into directional overcurrent relay

Set the phase angle so that the relay is not in restraint.

Set the 50A-3PH mk2 timer mode to “off”

Press the 50A-3PH mk2 “output on” pushbutton and increase the desired test current for each phase.

Switch the output off using the “output off” pushbutton.

Select “internal start” timer mode, and switch the output on. The unit now resets and starts the timer and starts injecting current into the relay. When the relay’s contacts change state, the timer will stop and the output will be switched off automatically.

4. MAINTENANCE

Before removing the unit from its case, ensure that the unit is disconnected from the mains. Under no circumstances connect the unit to the mains whilst it is removed from its case.

4.1 Regulator Brushes

The regulator brushes should be examined and replaced if necessary. The interval between inspection and renewal of the brushes will depend upon the amount of usage. However, it should be remembered that damage to the regulator can result if the brushes are allowed to wear away to such an extent that a loss of brush pressure occurs.

4.2 Removal of the 50A-3PH mk2 from Case

To remove the instrument from its case, the following procedure should be used:-

- a. Remove the lid from the case, and place the unit on its face, such that it is resting on the handles on the front panel.
- b. Remove the four fixing screws from the base of the unit.
- c. Lift the case from the unit.

5. STANDARD ACCESSORIES

5.1. Spares fuses supplied:-

- a. 3 off T2A 1¼ inch mains supply
- b. 1 off T315mA 20mm auxiliary supply
- c. 1 off F6.3A auxiliary current input

5.2. Standard Accessories Supplied

- a. Mains input lead.
- b. 3 off 3m 4mm² black output leads
- c. 1 off 3m 4mm² red output lead
- d. 1 off 3m 4mm² yellow output lead
- e. 1 off 3m 4mm² blue output lead
- f. 1 off 3m 2.5mm² red output lead
- g. 1 off 3m 2.5mm² black output lead
- h. 2 off 0.5m 2.5mm² output leads
- i. Operating & Maintenance Manual
- j. Lead set case

6. OPTIONAL DELTA-STAR TRANSFORMER

6.1 Description

The 50A-3PH mk2 Delta-Star transformer allows the 400V 50A-3PH mk2 to be used where only a three wire three phase supply is available. It also allows operation of the unit from 115V, 230V, 400V and 440V line-line supplies.

An auxiliary single phase output is provided to supply power to a DVS3 voltage source. A separate transformer supplied from phases A and C powers this output.

6.1.1 Front Panel Layout

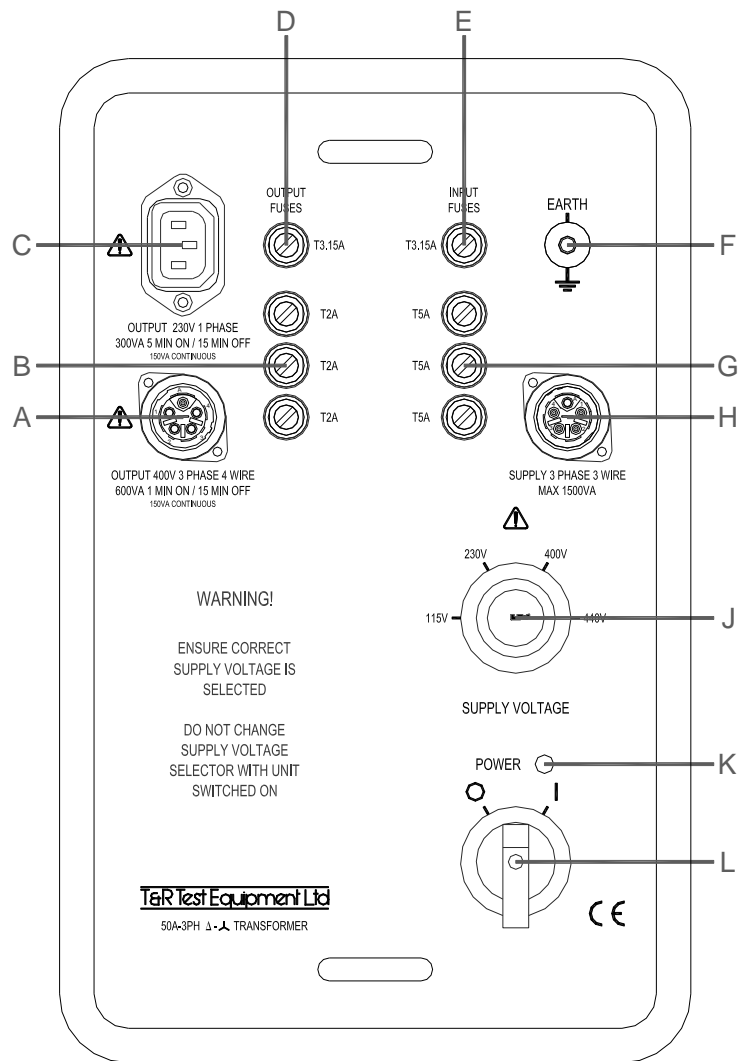

Figure 6.1 Delta-Star transformer front panel layout

Ref	Item	Function
A	Mains outlet - 4 wire	400V 4 wire output to 50A-3PH mk2
B	3 phase output fuses	Three phase output fuses
C	Single phase output	230V single phase output for DVS3
D	Single phase output fuse	Fuse for single phase output
E	Single phase input fuse	Fuse for single phase output
F	Earth terminal	Connection to local earth
G	Three phase input fuses	Three phase input fuses
H	Mains input – three wire	115V-440V three wire input
J	Input voltage selector keyswitch	Input voltage selector switch
K	Mains on/off indicator	Lit when power is on
L	Mains on/off switch	Isolate unit from mains

6.1.2 Electrical Specification

6.1.2.1 Supply Requirements

The input to the delta-star converter is a 3 wire three phase supply. The input may be switched to one of the following voltages:

- 115V±10% 3 phase 3 wire 1500VA max
- 230V±10% 3 phase 3 wire 1500VA max
- 400V±10% 3 phase 3 wire 1500VA max
- 440V±10% 3 phase 3 wire 1500VA max

6.1.2.2 Three Phase Output

A three phase output is provided to supply the 50A-3PH mk2. Do not connect any other type of equipment to this output.

Voltage: 400V±10%

Type: 4 wire 3 phase isolated from mains

Rating: 200VA continuous/600VA 1 min on/15 min off

6.1.2.3 Single phase output

A single phase output is provided to supply the DVS3. Do not connect any other type of equipment to this output.

Voltage: 230V±10% single phase

Type: Single phase isolated from mains and three phase output

Rating 150VA continuous/300VA 5 min on/15 min off

6.2 Operation

6.2.1 Supply Voltage Connections

The 50A-3PH mk2 delta-star transformer is supplied with a 4 core supply cable. The cores are marked to ensure correct phase rotation. The mains input lead is marked as follows:

L1	Brown
L2	Black
L3	Grey
Earth	Green and yellow

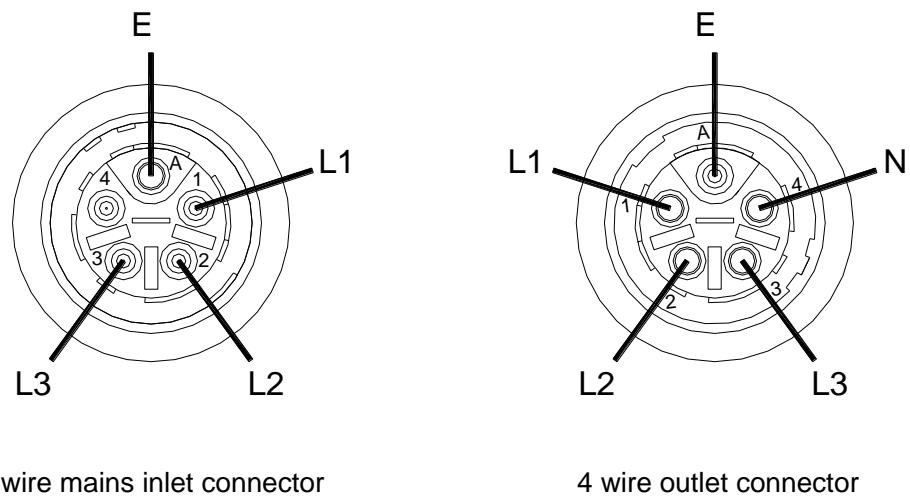

Figure 6.2 Mains inlet and three phase output connectors

6.2.2 Connections between units

Ensure that the supply is switched off.

Set the supply voltage selector key switch to match the supply voltage. SETTING THIS SWITCH TO THE WRONG VOLTAGE MAY DAMAGE THIS UNIT AND ANY EQUIPMENT CONNECTED TO IT.

DO NOT SWITCH THE SUPPLY VOLTAGE SELECTOR WITH POWER APPLIED.

Connect the three phase output from the delta-star transformer to the 50A-3PH mk2 using the interconnecting lead supplied.

Connect the single phase output from the unit to the DVS3, if required.

Switch on the supply.

Switch on the delta-star transformer.

Switch on the 50A-3PH mk2 and DVS3.

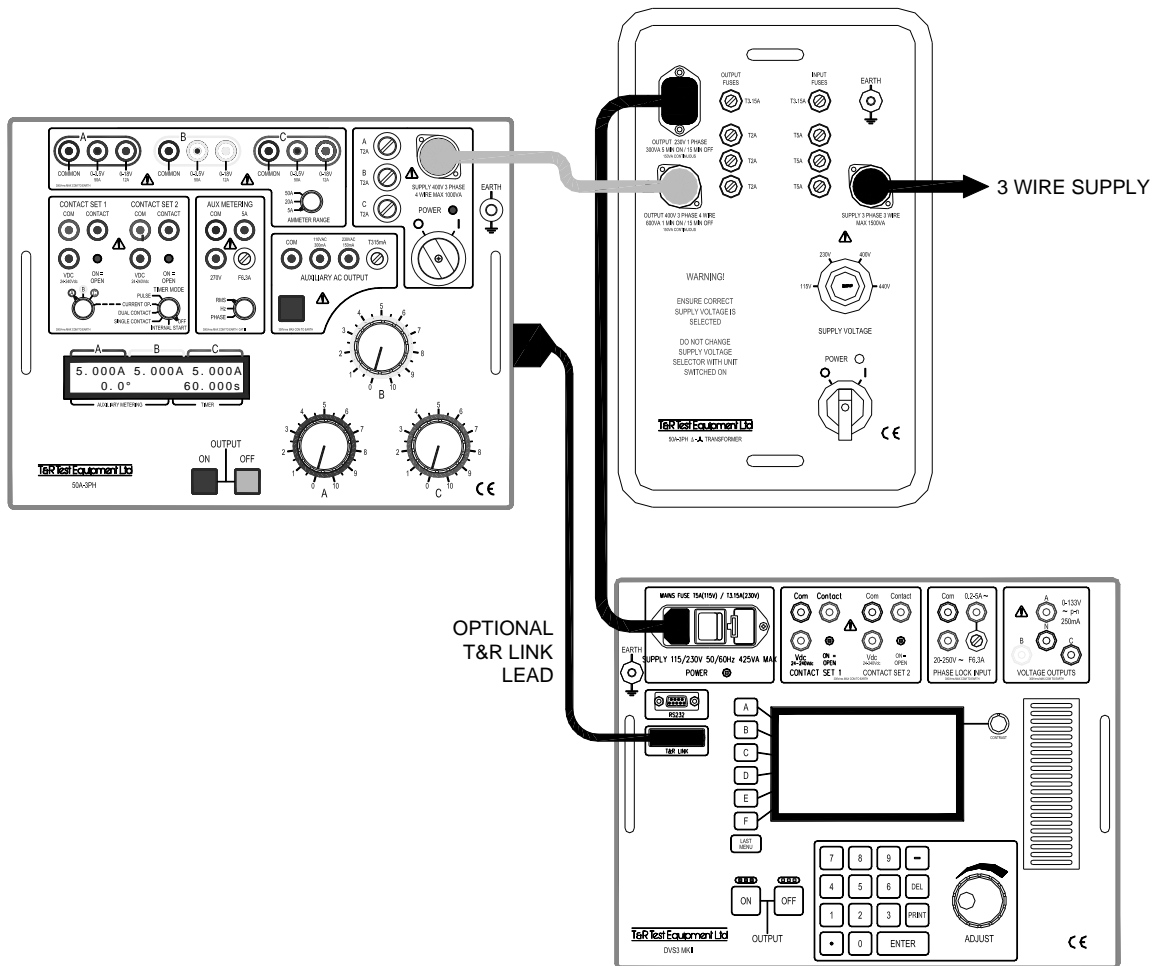

Figure 6.3 Connections between units

7. OVERALL PERFORMANCE SPECIFICATION

7.1. Insulation Resistance at 1000V DC

The insulation resistance will not be less than 10 megohms between mains input to frame and all isolated outputs, and all combinations of isolated output to isolated output.

7.2. Applied Voltage Test

Mains input to frame: 2.0kV RMS for 1 minute.

All combinations of isolated output to isolated output and isolated output to frame: 1.0kV for 1 minute

7.3. Accuracy of Instrumentation and associated circuit components

7.3.1 Main Output Ammeter

	Range	Resolution	Accuracy
True rms ac current	5.000A	0.001A	$\pm 0.6\%$ rdg $\pm 5d$
True rms ac current	20.00A	0.01A	$\pm 0.6\%$ rdg $\pm 5d$
True rms ac current	50.00A	0.01A	$\pm 0.6\%$ rdg $\pm 5d$

7.3.2 Auxiliary Metering

	Range	Resolution	Accuracy
True rms ac voltage	0-270.0Vac rms	0.1V	$\pm 0.7\%$ rdg $\pm 5d$
True rms ac current	0-5.000Aac rms	0.001A	$\pm 0.7\%$ rdg $\pm 5d$
Frequency (V)	40.00-99.99Hz	0.01Hz	$\pm 0.2\%$ rdg $\pm 2d$
Frequency (I)	40.00-99.99Hz	0.01Hz	$\pm 0.2\%$ rdg $\pm 2d$
Phase (V)	$\pm 180.0^\circ$	0.1°	± 3 degrees
Phase (I)	$\pm 180.0^\circ$	0.1°	± 3 degrees

7.3.3. Timing System

Timer mode	Range	Resolution	Accuracy
Internal start	0-999.999s/ 0-9999.99s/ 0-99999.9s	1ms/10ms/100s	$\pm 0.01\%$ rdg $\pm 2d$
Single contact			$\pm 0.01\%$ rdg $\pm 2d$
Dual contact			$\pm 0.01\%$ rdg $\pm 2d$
Current operated			$\pm 0.01\%$ rdg $\pm 4d$
Pulse mode	200ms	1ms	$\pm 2ms$

8. REVISION

Product / Type: Secondary Current Injection Test Set / 50A-3PH mk2
File: 50A-3PH mk2 manual v3.doc

Author: I.D.W. Lake

Issue / Date: 3 / 24.06.2013

Modified By: T Clark

Checked By: P Cole	Date: 24.06.2013
--------------------	------------------

Drawings Required

A2/001769 latest issue (50A-3PH mk2)